

# ***POWERSTATION***



## **Model P1 User Guide**

**CTC** COMPUTER  
TECHNOLOGY  
CORPORATION



# ***POWERSTATION***

## **Model P1 User Guide**

A3-05087-101

# Copyright and Trademark Notice

Copyright (C) 1997 by Computer Technology Corporation. All rights reserved. No part of this publication may be reproduced, transmitted, transcribed, stored in a retrieval system, in any form or by any means, mechanical, photocopying, recording or otherwise, without the prior written consent of Computer Technology Corporation.

While every precaution has been taken in the preparation of this manual, Computer Technology Corporation and the author assume no responsibility for errors or omissions. Neither is any liability assumed for damages resulting from the use of the information contained herein. All product and company names are trademarks of their respective companies and licenses.

Computer Technology Corporation  
50 W. TechneCenter Drive  
Milford, OH 45150-2739  
(513) 831-2340  
Technical Support (513) 248-1714  
User Guide Part #: A3-05087-101

# Table of Contents

---

<b>Chapter 1 Getting Started</b> . . . . .	<b>1</b>
Documentation Components . . . . .	2
Documentation Standards . . . . .	2
Important Concepts . . . . .	3
Before You Begin . . . . .	3
Configuring the PowerStation . . . . .	3
Developing an Interact Application . . . . .	4
Create an application . . . . .	4
Test the application . . . . .	4
Download the application . . . . .	4
Installing the PowerStation . . . . .	4
Customer Support Services . . . . .	5
Customer Technical Support . . . . .	5
Technical Support Products . . . . .	6
Product Support Program . . . . .	6
<b>Chapter 2 Understanding the P1 PowerStation</b> . . . . .	<b>7</b>
Display Types . . . . .	8
Color STN Display . . . . .	8
Monochrome Display . . . . .	8
Drive Definitions and Memory Map . . . . .	8
P1 PowerStation Memory Map . . . . .	9
Memory Guidelines . . . . .	10
Available Connectors . . . . .	10
Serial Ports . . . . .	10
COM1 pinouts . . . . .	11
COM2 pinouts . . . . .	11
Cable diagrams . . . . .	12
Connecting to a PC . . . . .	13

# Table of Contents

---

Connecting a serial mouse . . . . .	13
Connecting to a serial printer. . . . .	15
Parallel Port . . . . .	16
Connecting to a parallel printer . . . . .	17
Keyboard Port . . . . .	17
Connecting a PS/2 mouse. . . . .	17
Ethernet Port . . . . .	17
<b>Specifications . . . . .</b>	<b>18</b>
Physical Specifications. . . . .	18
Electrical Specifications . . . . .	19
Testing Specifications . . . . .	19
Environmental Specifications. . . . .	20
Faceplate Chemical Resistance. . . . .	20
<b>Replacement Components . . . . .</b>	<b>21</b>
Flash Drive . . . . .	21
DRAM. . . . .	21
Touch Screen. . . . .	21
Backlight Bulb . . . . .	22
<b>Optional Components . . . . .</b>	<b>22</b>
AC Power Supply. . . . .	22
PC/104 Adapter . . . . .	22
<b>Chapter 3 Configuring the P1 PowerStation. . . . .</b>	<b>23</b>
Powering Up the PowerStation. . . . .	24
Using the Shell Utility . . . . .	24
Selecting Screen Options. . . . .	25
Menu Definitions . . . . .	25
Main Menu. . . . .	25
Help . . . . .	26

# Table of Contents

---

Settings . . . . .	27
System Information . . . . .	29
Touch Screen Calibration . . . . .	30
Go To Interact . . . . .	31
Exit. . . . .	31
Calibrating the Touch Screen . . . . .	31
Configuring the Ethernet Interface. . . . .	33
Modifying the AUTOEXEC.BAT File . . . . .	34
Address/IRQ Considerations. . . . .	35
<b>Chapter 4 Installing the P1 PowerStation. . . . .</b>	<b>37</b>
Selecting a Location . . . . .	38
Environmental Guidelines . . . . .	38
Faceplate considerations. . . . .	38
Electrical Guidelines. . . . .	38
Temperature Guidelines. . . . .	38
Enclosure Guidelines. . . . .	39
Backlight Accessibility Guidelines . . . . .	39
AC Power Guidelines. . . . .	39
Preparing the Location . . . . .	40
Creating the Cutout . . . . .	40
Preparing to Use an AC Power Supply . . . . .	40
Installing the Unit. . . . .	41
Mounting the PowerStation . . . . .	41
Mounting the AC Power Supply . . . . .	41
Installing the PC/104 Adapter . . . . .	42
Electrostatic Discharge Precautions . . . . .	42
Installing the Adapter . . . . .	43

# Table of Contents

---

<b>Chapter 5 Maintaining and Troubleshooting the P1 PowerStation</b> . . . . .	<b>45</b>
Cleaning the Touch Screen. . . . .	46
Replacing the Flash Drive. . . . .	46
Performing Internal Maintenance . . . . .	47
Electrostatic Discharge Precautions . . . . .	47
Disassembling the PowerStation . . . . .	48
Changing the COM2 Jumpers . . . . .	50
Replacing the DRAM . . . . .	52
Replacing the Touch Screen . . . . .	53
Replacing the Backlight Bulb. . . . .	54
Reassembling the PowerStation . . . . .	56
Resolving Common Problems. . . . .	58
Resolving Problems When Powering the Unit . . . . .	58
Resolving AUTOEXEC.BAT and CONFIG.SYS problems . . . . .	58
Resolving other problems during power up . . . . .	59
Resolving Problems After Powering the Unit . . . . .	61
<b>Index</b> . . . . .	<b>65</b>



# Getting Started

Thank you for purchasing the P1 PowerStation. The P1 PowerStation is a rugged, compact PC that is designed to be used as an industrial operator interface. You will find that the P1 PowerStation has been built to provide years of trouble-free operation even in the harshest environments.

The P1 PowerStation features a durable 5.7" STN color LCD or Mono LCD display, an all-in-one PC board with a parallel port, two serial ports, and an Ethernet port. The P1 PowerStation's PC architecture allows you to run CTC's Interact software.

Please take a moment to review this manual and all other documentation included with the P1 PowerStation.

## Chapter Contents

<i>Documentation Components</i>	2
<i>Documentation Standards</i>	2
<i>Important Concepts</i>	3
<i>Customer Support Services</i>	5

## Documentation Components

The P1 PowerStation documentation set contains all the information you need to configure, install, and use the P1 PowerStation as well as information about the PowerStation Shell Utility program and the Interact Project Manager. The P1 PowerStation documentation set is described below.

**P1 PowerStation Template** - This document is a full-size template of the P1 PowerStation you can use to prepare the location where you want to install the unit.

**Release Notes** - This document provides important information about the P1 PowerStation that does not appear in this manual. Be sure to read the release notes before operating the unit.

**P1 PowerStation User Guide** - This document is the document you are reading. It provides detailed information about the P1 PowerStation and describes how to configure, install, and use the unit. It also contains information about the PowerStation Shell Utility. Please read this manual in its entirety prior to operating the unit.

**IPM User Guide** - This document describes how to install and use the Interact Project Manager to download Interact projects from a PC to the P1 PowerStation.

**Program Disks** - A disk sleeve contains the source disks for the CTC software that was installed on your unit at CTC.

## Documentation Standards

As you read this manual, you will notice that the following documentation standards have been followed.

1. Important terms are shown in **bold**.
2. Text to be entered from the keyboard is shown in `Courier` font.
3. Buttons, menu titles, and keyboard keys are shown in Initial Caps.
4. Indented paragraphs denote one of the following:
  - **Note** - Describes alternative approaches or issues you should be aware of while using a particular function.

- **Important** - Contains information that needs particular attention while reading the text. Follow this information to save development time and/or minimize problems.
- **Warning** - Contains information on safety issues. Follow this information to prevent equipment damage or personal injury.

## Important Concepts

Now that you have opened the PowerStation package, you are ready to unpack the unit, configure it, and install it in a permanent location. This section provides an overview of the steps that are discussed in detail throughout the remainder of this manual.

## Before You Begin

Before you begin operating the PowerStation, please complete the following steps:

1. Unpack the PowerStation, and verify that you have received all the components you ordered. The components that were shipped with the unit are listed on the packing list included in the PowerStation carton.
2. Fill out the product registration card, and return it to CTC. When you register your unit, you will receive a trial membership in CTC's Product Support Program that provides complimentary telephone technical support, information on product updates, and service bulletins.
3. Backup the CTC software disks that came with your unit using the Windows® File Manager/Explorer or the MS-DOS® **diskcopy** command.
4. Read the P1 PowerStation Release Notes. This document provides important information about the P1 PowerStation that does not appear in this manual.

## Configuring the PowerStation

Once you have unpacked the PowerStation and completed the steps listed in the previous section, you are ready to power up the PowerStation for the first time and configure the system defaults. Detailed information on configuring the PowerStation is described in Chapter 3.

## Developing an Interact Application

The P1 PowerStation is designed to run applications you create using CTC's Interact application development software. The P1 PowerStation is a runtime-only system which means you must develop applications on a PC and download them to the PowerStation.

**Important** Throughout this manual all references to 'development PC' or 'development system' refer to the computer you use to develop Interact applications.

### Create an application

If you are new to Interact, read the Interact Getting Started Manual to learn more about the software. This manual includes example applications you can modify and run, providing hands-on experience with each Interact module.

Interact also has extensive online help files that you can use to answer any of your development questions.

### Test the application

When you finish creating an application, you should test it prior to running it in a production environment. If you create an application on a PC using Interact, you can use Interact's Test Mode to test the application before downloading it to the PowerStation.

### Download the application

When you finish developing an application on a PC using Interact, you can use the Interact Project Manager (IPM) to assign the application to a project and download it to the PowerStation. Refer to the Interact Project Manager User Guide for more information about downloading projects to the PowerStation.

## Installing the PowerStation

When you finish unpacking the PowerStation and developing an application, you are ready to install the unit in a permanent location. Detailed information on installing the PowerStation is described in Chapter 4.

## Customer Support Services

CTC welcomes your thoughts and suggestions on our products and services. You can contact CTC by telephone, email, or fax. You can also visit CTC on the World Wide Web to learn the latest about CTC hardware, software, and customer support services.

Telephone: 513-831-2340

Fax: 513-831-5042

E-mail: [sales@ctcusa.com](mailto:sales@ctcusa.com) or [support@ctcusa.com](mailto:support@ctcusa.com)

World Wide Web: <http://www.ctcusa.com>

CTC recognizes that every customer and every application has different support needs so CTC offers a variety of support services designed to meet these needs. CTC offers three types of customer support services: Customer Technical Support, Technical Support Products, and the Product Support Program.

## Customer Technical Support

The Customer Technical Support department welcomes any question, day or night, that might arise as you develop or run your applications. We offer complimentary support for any customer, whether you are an end user, original equipment manufacturer (OEM), system integrator, or distributor.

If you have a question about the PowerStation, be sure to complete the following steps:

1. Check the release notes shipped with the unit. These notes provide important information about the PowerStation.
2. Consult the PowerStation documentation and other printed materials included with the PowerStation.
3. Review Chapter 5 of this manual, "Maintaining and Troubleshooting the P1 PowerStation".

If you cannot find a solution using one of the above sources, contact CTC's Customer Technical Support department. You can contact the Customer Technical Support department by phone at 513-248-1714 (24 hours/day for emergency service) or by email at [support@ctcusa.com](mailto:support@ctcusa.com).

## Technical Support Products

Our Technical Support Products department provides service in two areas: training and consulting. CTC offers training on all our products either at CTC in our state-of-the-art training center or at your site. You can learn how to write custom interfaces, develop specialized applications, and implement your complete operator interface application. You can contact the Training Coordinator by phone at 1-800-233-3329 or by email at [training@ctcusa.com](mailto:training@ctcusa.com).

CTC offers consulting services through our Professional Consulting Services (PCS) group. Our PCS group can build your application from the ground up by writing custom communications drivers or designing special modules to perform functions unique to your application. Our team of specialists is flexible so they can create a project development schedule that meets your needs. You can contact the PCS Coordinator by phone at 1-800-233-3329 or by email at [pcs@ctcusa.com](mailto:pcs@ctcusa.com).

## Product Support Program

Our Product Support Program (PSP) consists of a renewable, one-year membership that provides you with free upgrades, utilities, tips and tricks, and other valuable tools for Interact. You can contact the PSP Coordinator by phone at 1-800-233-3329 or by email at [psp@ctcusa.com](mailto:psp@ctcusa.com).

# Understanding the P1 PowerStation

The P1 PowerStation is designed to give you an operator interface solution that is powerful, cost-effective, and very easy to use. The PowerStation family of workstations is available in a variety of configurations to fit the functionality and cost requirements of your application.

In this chapter you will learn about the P1 PowerStation's drive definitions and memory maps, connectors, and other important specifications.

## Chapter Contents

---

<i>Display Types</i>	8
<i>Drive Definitions and Memory Map</i>	8
<i>Available Connectors</i>	10
<i>Specifications</i>	18
<i>Replacement Components</i>	21
<i>Optional Components</i>	22

## Display Types

The P1 PowerStation is available with two types of LCD displays: Color STN and Monochrome. Each display measures 5.7 inches across with a resolution of 320 x 240 1/4 VGA.

### Color STN Display

The Color STN touch screen displays up to 256 colors at 320 x 240 1/4 VGA.

**Note** On the Interact Settings dialog, Run Mode Display tab, you must set the Display Color to **Color**.

### Monochrome Display

The Monochrome touch screen displays up to 16 colors at 320 x 240 1/4 VGA.

**Note** On the Interact Settings dialog, Run Mode Display tab, you must set the Display Color to **Gray**.

## Drive Definitions and Memory Map

This section provides information about the P1 PowerStation's drive definitions, depending on the type of storage device. This section also includes a graphical illustration of the P1 PowerStation memory map.

Drive Letter	Type	Size	Usage
C:	Flash Disk (Read/Write)	4MB	System boot drive and Project disk. Stores the project, Interact, applications, etc. Download files to this drive.



## P1 PowerStation Memory Map

The following graphic illustrates how the P1 PowerStation allocates conventional memory and extended memory. The range of address references is listed next to each device.

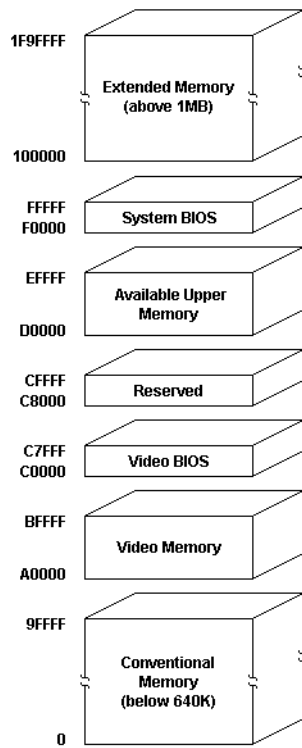

## Memory Guidelines

Refer to the memory guidelines listed below when you develop Interact applications. The following table lists guidelines to follow concerning the use and capacity of memory used for runtime and development systems.

Memory	Capacity
DRAM	4MB standard; upgradable to 16MB. 4 MB will run APM, PTM runtime modules and 2 drivers.
Flash Drive	4MB standard; additional flash drives are available.

## Available Connectors

The P1 PowerStation includes many of the same ports found on most PC's. All P1 PowerStations have two serial ports, a parallel port, a PS/2 style keyboard/mouse port, and an Ethernet connector. The following graphic shows the available connectors on a typical P1 PowerStation.

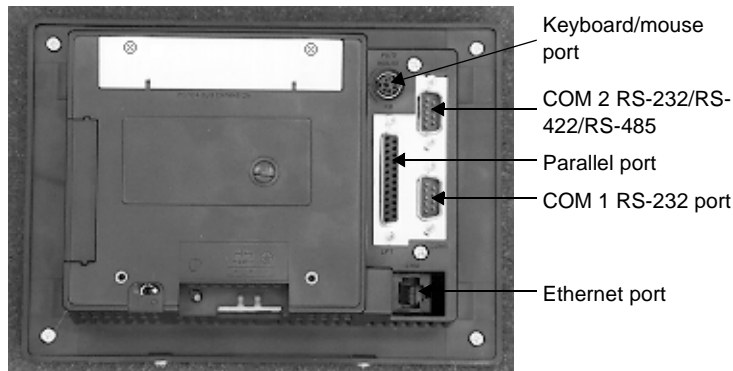

## Serial Ports

The P1 PowerStation has two serial ports you can use to communicate with external devices at baud rates of up to 115 Kbaud. COM1 supports RS-232C, while COM2 supports RS-232C, RS-422, and RS-485 communication standards.

The communication standard you select for COM2 depends on the distance between the PowerStation and the controller as well as the communication standards that the controller supports. Use a standard DB9 connector for communicating with this port.

**Note** If you are using RS-232-C communications, the length of the serial cable should not exceed 50 feet (15 meters).

RS-422 and RS-485 communications offer greater noise immunity than RS-232-C. These standards increase the maximum cable length to 4000 feet (1200 meters).

RS-422 communications are full-duplex (can send and receive simultaneously) while RS-485 communications are half-duplex (can only send or receive at one time).

For either configuration, be careful not to connect any wires to unused connector pins. Information on the specific connection required for the Interact driver you use is located in the Help file associated with the driver.

## COM1 pinouts

If you need to make a cable for communicating with COM1, the following table shows the pinouts and signal information for this port.

Pin#	Signal
1	DCD, data carrier detect
2	RXD, received data
3	TXD, transmitted data
4	DTR, data terminal ready
5	Signal ground
6	DSR
7	RTS, request to send
8	CTS, clear to send
9	RI

## COM2 pinouts

If you need to make a cable for communicating with COM2, the following table shows the pinouts and signal information for this port. COM2 is set to the RS-485 protocol by default. To change COM2 to the RS-232-C or RS-422 protocols, you must change the COM2 jumper settings.

## Available Connectors

See *Changing the COM2 Jumpers* on page 50 for these procedures.

Pin#	RS-232-C Signal	RS-422 Signal	RS-485 Signal
1	DCD, data carrier detect	TXD-, transmitted data -	TXD-, transmitted data -
2	RXD, received data	TXD+, transmitted data +	TXD+, transmitted data +
3	TXD, transmitted data	RXD+, received data +	RXD+, received data +
4	DTR, data terminal ready	RXD-, received data -	RXD-, received data -
5	Signal ground	Signal ground	Signal ground
6	DSR, data set ready	DSR, data set ready	DSR, data set ready
7	RTS, request to send	RTS, request to send	RTS, request to send
8	CTS, clear to send	CTS, clear to send	CTS, clear to send
9	RI	RI	RI

## Cable diagrams

The following graphics represent the pinouts and cable diagrams required for communicating with COM1 or COM2 using the RS-232-C protocol. Also shown are cable diagrams for communicating with COM2 using the RS-422 or RS-485 protocols.

**Important** Be careful not to connect any wires to unused connector pins.

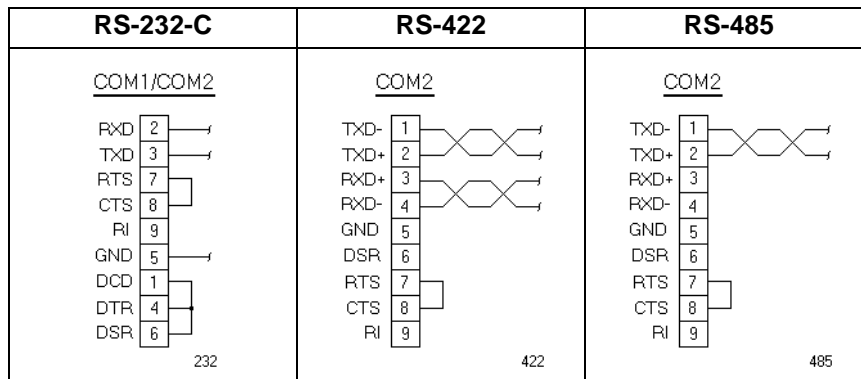

## Connecting to a PC

To transfer files from a PC to the PowerStation, connect a serial cable with a null modem to an available serial port on the PC. Connect the other end of the cable to the serial port on the PowerStation. If you need to construct your own cables, refer to the figures below.

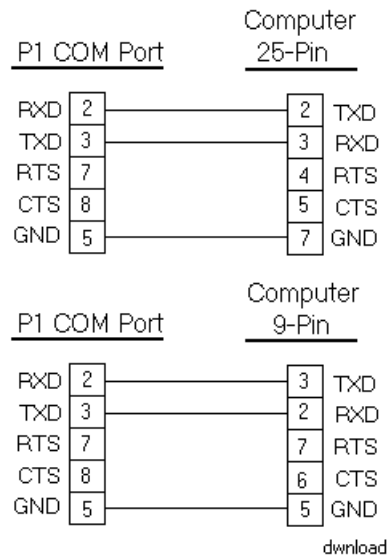

## Connecting a serial mouse

If you need to connect a serial mouse to the PowerStation, you must follow the procedures defined in this section. However, CTC does not recommend using a serial mouse for the following reasons:

- A serial mouse will occupy one of your serial ports that could be used for downloading or data logging.
- You cannot use a serial mouse and the touch screen simultaneously. The PowerStation will only load the driver for the device that is listed first in the AUTOEXEC.BAT file.
- The serial port you use must be configured for RS-232-C communications. If you use COM2, you may need to reconfigure this port to use the RS-232-C protocol. See *Changing the COM2 Jumpers* on page 50.

If you still find it necessary to use a serial mouse, follow these steps to configure the PowerStation:

1. If you will be using COM2, verify that it is configured for RS-232-C communications. See *Changing the COM2 Jumpers* on page 50 to change the communications protocol for this port.
2. Connect the PowerStation to your development PC. See *Connecting to a PC* on page 13 for more information.
3. Run the Interact Project Manager (IPM) on your development PC, and enter Super User mode. Refer to the IPM User Guide for more information about Super User mode.
4. Use IPM Super User mode to copy the file MOUSE.COM from your development PC to the PowerStation. You can obtain a copy of this file from Microsoft.
5. Run MS-DOS Edit to edit the PowerStation's AUTOEXEC.BAT file.

**Note** You may encounter an out of memory error on your development PC if you attempt to load IPM and MS-DOS Edit at the same time. If you encounter this error, reduce the number of device drivers and/or TSRs that reside in conventional memory.

6. Add the following line to AUTOEXEC.BAT before the lines that load the touch screen driver. The 'x' specifies the serial port (1 or 2):

```
C:\MOUSE.COM /Cx
```

**Important** You must specify the location on the PowerStation where you copied MOUSE.COM. You must also specify the serial port number because MOUSE.COM will always find the PS/2-connected touch screen controller before the serial-connected mouse, causing neither device to work properly.

7. Save the AUTOEXEC.BAT file, and exit Super User mode.
8. Reboot the PowerStation. When the PowerStation Shell MAIN MENU appears, select the SETTINGS menu.
9. Select the DOWNLOAD ENABLE command, and disable downloading to the port that you are using for the serial mouse.
10. Connect the serial mouse to the port you configured, and reboot the PowerStation.

## Connecting to a serial printer

To connect a serial printer to the PowerStation you will need to change the mode settings for one of the serial ports to match those of your printer. The easiest way to change these settings is to use MODE.COM. MODE.COM can modify the following options:

**baud:** 110, 150, 300, 600, 1200, 2400, 4800, 9600

**parity:** N - none, O - odd, E - even

**databits:** either 7 or 8

**stopbits:** either 1 or 2

To use MODE.COM, complete the following steps:

1. Create a new AUTOEXEC.BAT file with the following line:  

```
MODE COM#:baud,parity,databits,stopbits
```
2. Copy this file and MODE.COM into the \STARTUP directory of the IPM project on your development system. CTC provides a copy of MODE.COM on the P1 ROM-DOS Utilities Disk.
3. Run Interact Project Manger (IPM), and download the project that contains AUTOEXEC.BAT and MODE.COM from your development system to the PowerStation.

During the download, IPM transfers the AUTOEXEC.BAT file you created in step 1 and MODE.COM into the \STARTUP directory specified by the INTERACT\_STARTUP environment variable. This environment variable resides in the PowerStation's AUTOEXEC.BAT.

When IPM finishes the download, the PowerStation automatically reboots, and MODE.COM configures the COM port to the required baud rate. For example, if you are communicating at 9600, NONE, 8, and 1, use:

```
MODE COM1: 9600,N,8,1
```

**Note** If you will be printing to a port that is configured for downloading, you must disable downloading for that port, and reboot the PowerStation. Rebooting the PowerStation allows MODE.COM to reset the communication settings for that port. Use the DOWNLOAD ENABLE command on the SETTINGS menu of the Shell to disable downloading.

## Available Connectors

- Use the following diagram as a reference when connecting a serial printer to the PowerStation.

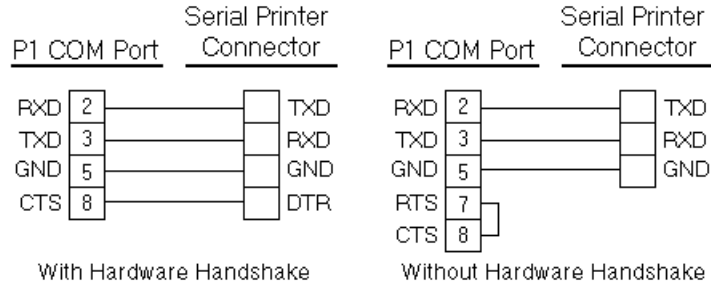

## Parallel Port

The PowerStation parallel port (LPT1) pinout is identical to the standard IBM parallel printer port. The LPT1 connector pinout is shown below.

Pin #	Signal Name
1	STROBE
2	DATA 0
3	DATA 1
4	DATA 2
5	DATA 3
6	DATA 4
7	DATA 5
8	DATA 6
9	DATA 7
10	- ACKNOWLEDGE
11	BUSY
12	PAPER EMPTY
13	+ SELECT
14	- AUTO FEED
15	- ERROR
16	- INIT PRINTER
17	- SELECT INPUT
18-25	GROUND



## Connecting to a parallel printer

The PowerStation can interface to any parallel printer designed for use with IBM PC compatible computers. Connect a printer to the port marked LPT using a standard IBM PC type parallel cable.

## Keyboard Port

The P1 PowerStation's CPU board includes a keyboard port that accepts any IBM AT compatible keyboard, including 84-key standard keyboards and 101-key enhanced keyboards. Connect the keyboard to the PowerStation using the supplied keyboard adapter cable.

**Note** PC/XT keyboards will NOT function on the PowerStation.

## Connecting a PS/2 mouse

If you prefer to use a mouse instead of the touch screen, CTC recommends that you use a Microsoft PS/2 style mouse with the supplied keyboard adapter cable. Using this cable allows the PowerStation to accept input from both the keyboard and the mouse. Connect the keyboard adapter cable to the keyboard port on the PowerStation.

## Ethernet Port

The P1 PowerStation has an Ethernet RJ-45 port that you can use to connect the PowerStation to a Local Area Network. This port is software compatible with the NE-2000 protocol and supports all major network operating systems.

Pin#	Signal
1	TX+
2	TX-
3	RX+
4	N/C
5	N/C
6	RX-
7	N/C
8	N/C

## Specifications

This section lists and describes some important specifications relating to the P1 PowerStation. Please familiarize yourself with these specifications prior to operating the P1 PowerStation.

### Physical Specifications

Physical specifications include the P1 PowerStation's physical characteristics, display types, memory specifications, and other physical details. Refer to the table below to learn more about these specifications:

Category	Specifications
Displays	<ul style="list-style-type: none"><li>• Monochrome LCD, 320x240 1/4 VGA, 16 shades of gray</li><li>• Color STN, 320x240 1/4 VGA, 256 colors</li></ul>
CPU	ALi M6117B, 40MHz 80386SX
BIOS	AMI 128KB Flash memory
Memory	4, 8, or 16 72-pin SIMM
Storage	4MB Solid State Flash (field expandable and replaceable)
I/O Ports	<ul style="list-style-type: none"><li>• 1 9-pin RS232 (16C550 compatible)</li><li>• 1 9-pin RS232/422/485 (16C550 compatible)</li><li>• 1 25-pin IBM parallel</li><li>• 1 PS/2 keyboard/mouse</li><li>• 1 RJ45 Ethernet (Novell NE-2000 compatible, on-board 10Base-T interface)</li></ul>
PC/104 Bus extension	Supports 8-bit, PC/104 subset; 8-bit mode only; +5V, +12V only;
PC/104 Adapter Dimensions	4.1" (104mm) x 4.4" (112mm) x 1.25" (32mm)
Dimensions	7.80" (198mm) x 5.60" (142mm) x 3.20" (81mm)
Weight	2.54 lbs. (1.15Kg)

## Electrical Specifications

The P1 PowerStation's electrical specifications appear in the table below:

Category	Specifications
Output rating	25W
Input voltage	18-30VDC
Output voltage	+5V@4A, +12V@0.5A

**Important** The PowerStation's power supply automatically detects the input voltage level and adjusts accordingly. However, use reliable sources of power to the PowerStation, and isolate all communication cables from AC power lines to enhance noise immunity.

If possible, locate the PowerStation away from machinery that produces intense electrical noise (arc welders, etc.). Otherwise, isolate the input power to the PowerStation from the equipment generating electrical noise.

## Testing Specifications

The P1 PowerStation conforms to the testing specifications listed in the table below:

Test	Specification
Showering arc	NEMA showering arc
Surge withstanding compatibility	IEEE 472-1974
ESD requirements	IEC 801-2
Operating temperature	IEC 68-2-1
Electrical fast transient	IEC 801-4
Operating vibration	IEC 68-2-6
Mechanical shock	IEC 68-2-27
Random vibration	MIL-STD-8100

## Environmental Specifications

The P1 PowerStation conforms to the environmental specifications listed in the table below:

Category	Specifications
Operating Temperature:	32 to 113°F (0 to 45°C) ambient (air temp. at case)
Storage Temperature:	-4 to 140°F (-20 to 60°C)
Relative Humidity:	0% to 95% non-condensing
Shock Rating:	<ul style="list-style-type: none"> <li>• 10g peak; 11ms (operating)</li> <li>• 30g peak; 30ms (non-operating)</li> </ul>
Operating Vibration:	<ul style="list-style-type: none"> <li>• 10 to 18 Hz: 1.5mm</li> <li>• 18 to 500 Hz: 1.0g</li> </ul>
Faceplate Rating:	NEMA 4/4X (IP65 European Standard) Environment

**Important** Limit the PowerStation’s exposure to adverse conditions such as dust, oil, moisture, and corrosive vapors to minimize maintenance and repair costs.

Remember that the temperature outside the protective enclosure is generally lower than the internal temperature. Thus, if the PowerStation is operating inside an enclosure at temperature levels above the maximum ambient temperature, you will need to cool the enclosure.

## Faceplate Chemical Resistance

The faceplate of the PowerStation can resist the chemicals listed in the table below with no visible effect.

Faceplate Chemical Resistance		
Acetone	Sulfuric Acid 10%	Motor Oil
MEK	Hydrochloric Acid 10%	Gasoline
Toluene	Acetic Acid 10%	Machine Oil
Methylene Chloride	Phosphoric Acid	Salad Oil
Isopropyl Alcohol	Sodium Hydroxide 10%	Silicone
Xylene	Carbon Tetrachloride	Silicone Grease G31
Hexane	Potassium Hydroxide	Kerosene
Butyl Cellosolve	Ammonia Water 10%	Gas Oil

Faceplate Chemical Resistance		
Cyclohexanone	Sodium Chloride 26%	Silicone Oil
Trichloroethylene	Zinc Chloride 81%	Engine Oil
Ethanol	Cottonseed Oil	Cleanser
Methanol	Glycerin	
Nitric Acid 10%	Grease	

## Replacement Components

The P1 PowerStation is designed to be a simple yet reliable unit to maintain. However, if you need to purchase replacement components for the P1 PowerStation, CTC carries a complete line of replacement components.

### Flash Drive

If you need additional storage capacity for the P1 PowerStation, you can purchase additional flash drives from CTC. CTC recommends that you purchase at least one additional flash drive to serve as a backup for your primary flash drive. See *Replacing the Flash Drive* on page 46.

### DRAM

If you need to upgrade or replace the P1 PowerStation's DRAM, CTC carries replacement SIMM modules. The P1 PowerStation comes with a 4MB 72-pin SIMM standard, but you can replace that module with either an 8MB or 16MB 72-pin SIMM for greater capacity. If you have mounted the unit in an enclosure, you will need to remove it before you can upgrade or replace the DRAM. See *Replacing the DRAM* on page 52.

### Touch Screen

Occasionally you will need to replace the P1 PowerStation's touch screen, depending on the environment where you are operating the P1. CTC carries replacement touch screens that you can easily replace without removing the unit from its enclosure. See *Replacing the Touch Screen* on page 53.

## Backlight Bulb

The P1 PowerStation's backlight bulb has an average life expectancy of 10,000 hours. CTC carries replacement bulbs that you can easily replace without removing the unit from its enclosure. See *Replacing the Backlight Bulb* on page 54.

## Optional Components

CTC carries two optional components that you may wish to purchase for the P1 PowerStation, an AC power supply and a PC/104 adapter.

### AC Power Supply

The P1 PowerStation uses DC power to save space and limit the amount of heat generated by the unit. However, if you require the P1 PowerStation to use AC power, you can purchase an AC power supply kit that includes an AC power supply, mounting brackets for the power supply, and a power cord. See *Preparing to Use an AC Power Supply* on page 40.

### PC/104 Adapter

The P1 PowerStation can be outfitted with a PC/104 adapter for communicating with 8-bit and 16-bit PC/104 cards in 8-bit, +5V, +12V mode. PC/104 cards are manufactured by numerous companies for a variety of purposes. See *Installing the PC/104 Adapter* on page 42.

# Configuring the P1 PowerStation

Now that you are familiar with some of the P1 PowerStation's features, it's time to configure your system. In this chapter you will learn how to use the Shell Utility software and the Touch Screen Calibration utility. You will also learn about address and IRQ considerations as well as how to modify the AUTOEXEC.BAT file, if necessary.

## Chapter Contents

---

<i>Powering Up the PowerStation</i>	24
<i>Using the Shell Utility</i>	24
<i>Calibrating the Touch Screen</i>	31
<i>Configuring the Ethernet Interface</i>	33
<i>Modifying the AUTOEXEC.BAT File</i>	34
<i>Address/IRQ Considerations</i>	35

## Powering Up the PowerStation

Once you have unpacked the PowerStation, you can power it up for the first time. Complete the following steps to power up the PowerStation:

1. Verify that the power switch is in the OFF position.
2. Connect the PowerStation to a 18-30VDC power source.

**Note** If you are using an AC power supply, you must first connect the power supply to the power connector on the back of the PowerStation. Connect the power supply to a 90 to 260VAC, 50-440HZ power source.

3. Move the power switch to the ON position.

## Using the Shell Utility

Prior to using the PowerStation you should understand the features available with the PowerStation Shell Utility. The PowerStation Shell Utility (referred to throughout this document as “the Shell”) is a program that runs on the PowerStation and is used to configure the unit and enable various features.

The Shell MAIN MENU is made up of a display area and two rows of selection buttons which are described in the Menu Definitions section. The display area contains information about the project currently loaded on the PowerStation. If no project exists, these settings will be set to NONE.

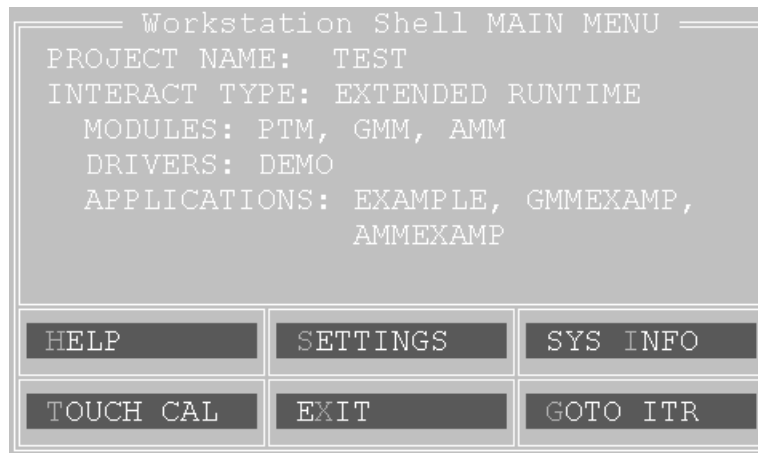



Upon selecting a submenu, you can return to the previous menu by:

- pressing the PREVIOUS button on the screen
- touching outside the pop-up menu area
- pressing the left mouse button outside the pop-up menu area
- pressing the Esc key on the keyboard
- pressing the right mouse button

Throughout the remainder of this section it is assumed that you are using a keyboard and mouse.

## Selecting Screen Options

To select screen options, touch the menu item, or move the cursor over the menu item you want to select, and press the left mouse button. A submenu of options appears that you can change for this menu item. If you need Help on an item, move the cursor over the item, and press the F1 key on the keyboard.

## Menu Definitions

This section provides a description of each item on the Shell MAIN MENU and the function of each selection button.

### Main Menu

When you power up the PowerStation, the Shell performs an internal check of the configuration settings for the unit and displays the Shell

MAIN MENU as shown below.

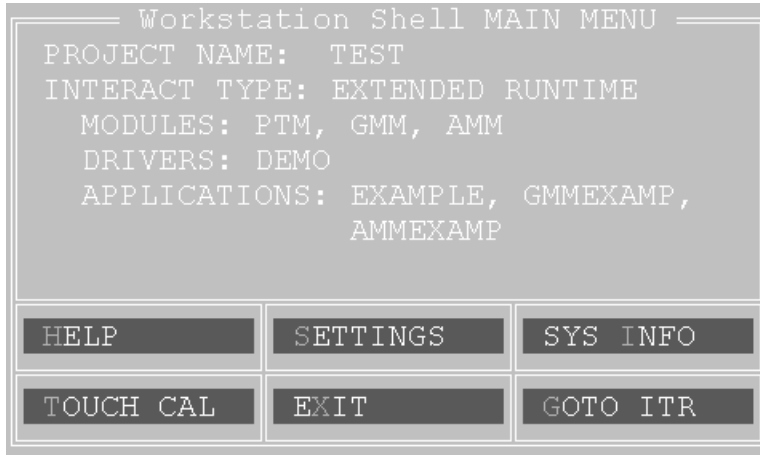

The lettered callouts are described below.

Name	Description
PROJECT NAME	Displays the name of the currently loaded project.
INTERACT TYPE	Displays whether Interact software is installed on your PowerStation. Will display either 'UNKNOWN' or 'EXTENDED RUNTIME'.
MODULES	Displays the abbreviated name of each Interact module installed with the application you are using on the PowerStation. For example, if the Panel Toolkit Module is loaded, the acronym 'PTM' is displayed.
DRIVERS	Displays the abbreviated name of each Interact driver installed with the application you are using on the PowerStation. For example, if the Siemens Programming Port driver is loaded, the acronym 'SIEMPP' is displayed.
APPLICATIONS	Displays a list of applications in the project that were created in Interact or copied from another project.

## Help

Select the Help button to enter the Shell help system. To request help on a menu button or option, move the cursor to the function, and press the F1

key on the keyboard. A page of text is displayed similar to the one below.

```
[ HELP ]
HELP ON P1 SHELL                               Page 1

      P1 POWERSTATION SHELL
      (c) 1997 CTC

To exit the help screen or a menu:
- touch outside of the window or menu
- touch the "Exit" menu selection
- press the [Esc] key on the keyboard
- press the right mouse button
                                           PgDn/Exit
```

To exit Help, press the Esc key on the keyboard, press the right mouse button, or click outside the Help box. If more than one page of information is available for an item, press the PgUp or PgDn buttons.

## Settings

Select the Settings button to change the PowerStation hardware settings. Once assignments have been made they are stored in the PWR.CFG file on drive C (flash disk).

**Important** The hardware configuration settings stored in the PWR.CFG file are saved on drive C (flash disk). Do not delete this file or you will have to reset the hardware configuration.

For most options, just select the item to toggle the selection. Other options display a submenu with additional selections. All changes made on this menu do not take effect until this menu is exited.

### POWER ON OPERATION

Use this option to select whether Interact or the Shell will run after the PowerStation is turned on. The selections are:

- RUN INTERACT
- SHELL MAIN MENU (default)

## Using the Shell Utility

---

If you select RUN INTERACT, the PowerStation loads Interact automatically without interaction from the user. When the user exits Interact, the Shell MAIN MENU is displayed. This selection is particularly useful if a power cycle should occur because the unit would automatically run Interact when the power is restored.

If you select SHELL MAIN MENU, then the PowerStation loads the Shell and displays the Shell MAIN MENU.

### DOWNLOAD ENABLE

Use this option to enable or disable the serial ports for downloading projects and applications to the unit.

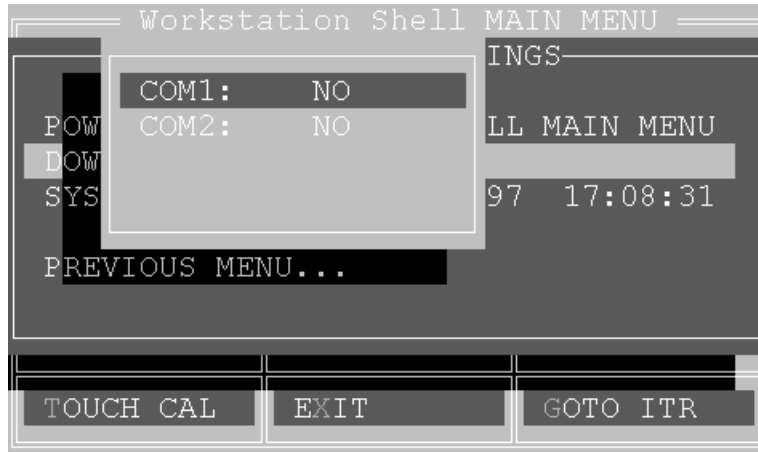

The Shell will not allow you to enable a serial port for downloading that is used by a mouse. Likewise, the Shell automatically disables any serial port enabled for downloading whenever it detects a mouse connected to it.

**Note** It is possible that all the download ports could become disabled by multiple changes to the configuration file. If this occurs, then you will have to manually enable them using the DOWNLOAD ENABLE setting on the SETTINGS menu.

## SYSTEM CLOCK

Use this option to change the PowerStation's date and time.

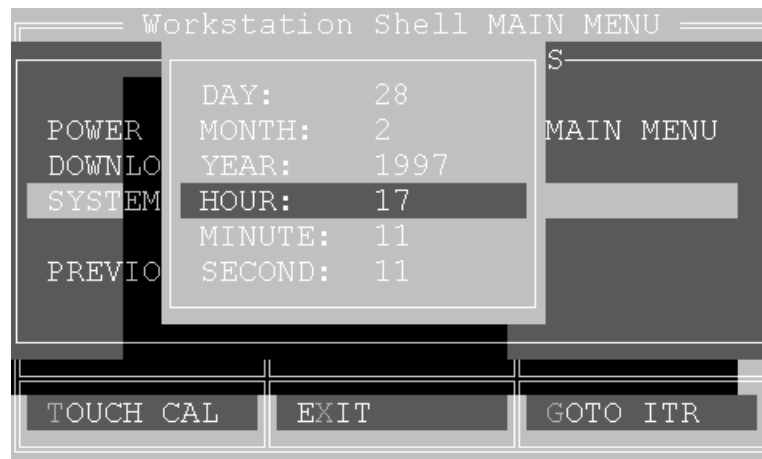

The range for each parameter is:

<b>DAY</b>	1 - 31	<b>HOUR</b>	0 - 23
<b>MONTH</b>	1 - 12	<b>MINUTE</b>	0 - 59
<b>YEAR</b>	1980 - 2099	<b>SECOND</b>	0 - 59

After selecting a parameter, use the Numeric Input Pad to enter the value desired.

## System Information

Select the SYS INFO button to provide information on system resources such as the Shell version number, processor type, installed memory, etc.

Use this information to assist you during PowerStation configuration. This information will be requested whenever you contact CTC's Customer Technical Support department for assistance.

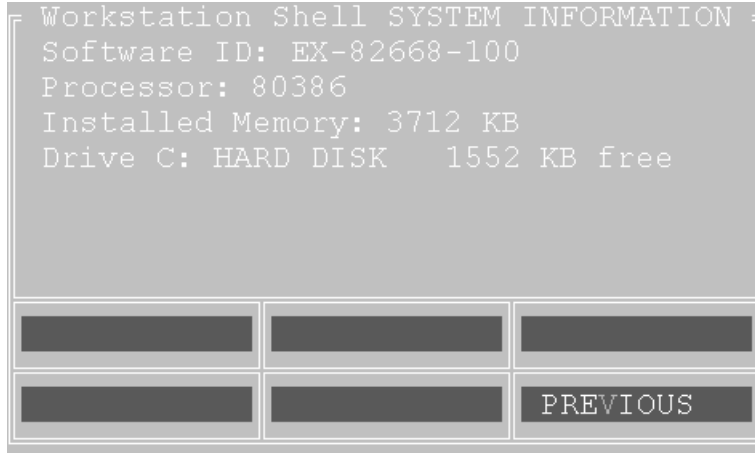

Name	Description
SOFTWARE ID	Identifies the version of the Shell utility.
PROCESSOR	Identifies the type of processor installed in the PowerStation.
INSTALLED MEMORY	Lists the amount of DRAM installed in the PowerStation in Kbytes.
DRIVES	Lists the type and size of the drives installed on the PowerStation along with the amount of free disk space.

## Touch Screen Calibration

Select this button to launch the touch screen calibration utility. When you select this button, a message window appears reminding you that the calibration utility requires a keyboard to perform the calibration. If you have a keyboard connected to the PowerStation, select YES to begin calibrating the touch screen. See *Calibrating the Touch Screen* on page 31 for more information about calibrating the touch screen.

## Go To Interact

Select the GOTO ITR button to execute Interact from the Shell. Doing so provides the proper environment for Interact to create and use the applications within the currently selected project.

The Interact module displayed is determined by the project's Startup Application configuration setting in the Application Manager. If this setting is None, then the Application Manager Main Menu is displayed.

Upon exiting Interact you will be returned to the Shell Main Menu.

## Exit

Select the EXIT button to exit the Shell program and return to DOS. When you select this button, the Shell reminds you that you must have a keyboard connected to the PowerStation before you can exit the Shell. If you have a keyboard connected to the PowerStation, select YES to exit the Shell.

You can restart the Shell at any time by typing PSU and pressing the Enter key on the keyboard.

# Calibrating the Touch Screen

The PowerStation's touch screen is calibrated prior to leaving CTC. However, you may need to recalibrate the touch screen occasionally. The PowerStation comes with a calibration utility that is required to perform this task. The calibration utility also requires a keyboard.

Once you have a keyboard connected to the PowerStation, you are ready to begin the calibration. The calibration procedure involves calibrating the touch screen for text and for graphics. Follow these steps to calibrate the touch screen:

1. From the Shell MAIN MENU, select the TOUCH CAL button. A message window appears reminding you that the calibration utility requires a keyboard to perform the calibration.
2. Select YES to start the calibration utility. The calibration main menu appears.
3. Verify that the Button Mode is set to Drag drop mode. If it is not, use the up/down arrow keys to highlight the words 'Button Mode,' and use the left/right arrow keys to display the Drag drop mode option.

## Calibrating the Touch Screen

---

4. Use the up/down arrow keys to highlight the word 'Calibration.'
5. Use the left/right arrow keys to display the VGA#03,720x400(80x25) option, and press Enter. The calibration screen appears.
6. Use an object with a blunt tip to touch the intersection formed between the cursor and the center of the screen. Using your finger will not provide accurate results. The PowerStation beeps when you touch the correct point. The graphic below demonstrates where to touch the screen.

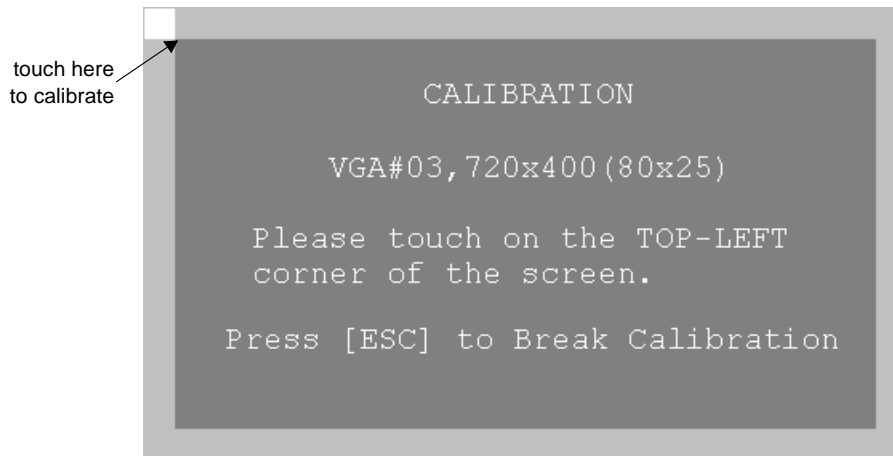

7. Repeat step 6 for each corner of the screen. The calibration utility automatically advances the cursor to each corner.
8. When you are finished, press the Esc key to return to the calibration main menu.
9. Use the left/right arrow keys to display the VGA#12,640x480(80x30) option, and press Enter. The calibration screen appears.
10. Complete step 6 for each corner of the screen. The calibration utility automatically advances the cursor to each corner.
11. When you are finished, press the Esc key to return to the calibration main menu.
12. Use the up/down arrow keys to highlight the words 'Save & Exit.'
13. Press the Enter key to save the calibration settings and return to the Shell MAIN MENU. The calibration utility saves the calibration settings in a file called ATSMOUSE.INI.



## Configuring the Ethernet Interface

The \NET directory of the PowerStation's flash disk contains a configuration utility and all drivers necessary to configure the Ethernet interface on the PowerStation. A list of these files appears below:

File Name	Description
RSET8019.EXE	A configuration utility you can use to change the interrupt and address of the Ethernet interface.
NET.BAT	A sample batch file you can use to run NetBIOS.
NET.CFG	Stores the interrupts and memory for the network drivers. The default PowerStation configuration reserves the following interrupts and I/O addresses. You cannot use these for the Ethernet interface. <ul style="list-style-type: none"> <li>• COM1: Int 4, I/O 3F8</li> <li>• COM2: Int 3, I/O 2F8</li> <li>• Touch Screen: Int 12</li> </ul> CTC recommends that you use the following interrupt and I/O address setting for the Ethernet interface: Int 10, I/O 240H
NETX.EXE	The Novell Netware shell program that makes the final connection with the server.
*LSL.COM	A Novell driver that enables the workstation to communicate with different protocols.
*IPXODI.COM	A Novell driver that supports the IPX protocol and other protocols over the same network.
*NE2000.COM	A Novell driver that supports the NE2000 protocol. It allows the network card to communicate with the network.
*NETBIOS.EXE	Used by Interact to communicate over a network.
* Denotes files that can be downloaded from Novell's FTP site: ftp://137.65.3.15/pub/updates/dsktop/nw111/111d03.exe	

Interact will also communicate over any network or operating system that supports NetBIOS protocols. Examples include Lantastic, TCP-IP, Microsoft, and IBM.

## Modifying the AUTOEXEC.BAT File

---

If you need assistance with NetBIOS and networking, contact CTC's Customer Technical Support department. See *Customer Technical Support* on page 5 for more information.

## Modifying the AUTOEXEC.BAT File

The following lines must appear in the AUTOEXEC.BAT file for proper operation of the P1 PowerStation. The AUTOEXEC.BAT file that CTC supplies includes these lines and is located in the \CTC directory of the PowerStation in a file called AUTOEXEC.CTC.

Command line parameters	Description
PATH C:; C:\CTC	Set up default DOS path
SET TCHPATH=C:\ATS	Set path for touch screen drivers
C:\ATS\ATSMOUSE	Initialize touch screen driver
SET INTERACT=C:\INTERACT	Set path for Interact software ONLY
SET INTERACT_FILES=C:\INTERACT\APPFILS	Set application path for Interact software ONLY
SET INTERACT_STARTUP=C:\STARTUP	Set startup variables for Interact software ONLY
IF EXIST C:\STARTUP\AUTOEXEC.BAT CALL C:\STARTUP\AUTOEXEC.BAT	Call second AUTOEXEC.BAT file if contained within a Project
C:\NET\NET.BAT (optional)	Load network batch file if unit is connected to a LAN
C:\CTC\PSU	Start the PowerStation Shell

See *Resolving AUTOEXEC.BAT and CONFIG.SYS problems* on page 58 if you encounter problems booting up the PowerStation.

## Address/IRQ Considerations

As in most ISA-bus computer port addresses, 300 through 32F are available for adapter functions. Make sure that any expansion cards you install do not conflict with these addresses.

**Important** The PowerStation reserves upper memory addresses from C8000 to CFFFF, while addresses D0000 to EFFFF are available for use by expansion cards. Be sure to follow these guidelines; address conflicts may cause improper operation of the PowerStation.

IRQs 5, 7, 9, 10, 11, and 15 are available to adapter devices connected to the ISA-bus. The PowerStation configures these as shown in the table below.

IRQ	Usage
3	COM2
4	COM1
5	
7	
9	
10	Ethernet default
11	
12	Touch Screen
15	



# Installing the P1 PowerStation

When you finish configuring the P1 PowerStation, you can begin making preparations to install the unit in a permanent location. This chapter will help you select an appropriate location for the unit, provide instructions for creating a cutout for the unit, and describe how to install the unit.

## Chapter Contents

---

<i>Selecting a Location</i>	38
<i>Preparing the Location</i>	40
<i>Installing the Unit</i>	41
<i>Installing the PC/104 Adapter</i>	42

# Selecting a Location

The first step to installing the PowerStation is to select an appropriate location for the unit. This is the most important aspect of the installation process because the location you select can affect the PowerStation's performance, ease-of-use, life-expectancy, and more. This section provides some guidelines that you should follow when selecting a location for the PowerStation.

## Environmental Guidelines

Environmental guidelines refer to the area where the PowerStation will be operated. In general, you should select a place that limits the unit's exposure to adverse conditions such as dust, oil, moisture, and corrosive vapors.

### Faceplate considerations

The PowerStation's faceplate is designed to the NEMA 4 (IP65 European standard) rating. You should mount the PowerStation in a similar enclosure to provide further protection.

The PowerStation's faceplate is also resistant to a variety of chemicals. Refer to the list on page 20 to ensure that the PowerStation's faceplate is only exposed to chemicals that appear on this list.

## Electrical Guidelines

To minimize unwanted electrical interference, select a location away from machinery that produces intense electrical noise. If this cannot be avoided, isolate input power to the unit, and separate all data communication cables used with the unit from AC power lines.

## Temperature Guidelines

You can safely operate the PowerStation at ambient air temperatures from 32 to 113° F (0 to 45° C). However, the temperature outside a protective enclosure is generally lower than the internal temperature. Thus, if the PowerStation is operating inside an enclosure at temperature levels above its rated ambient temperature, you will need to cool the enclosure.

---

## Enclosure Guidelines

Select an enclosure that is large enough to allow free airflow in and around the unit. You should allow a minimum of a 2 inch gap between the enclosure and the top, bottom, and sides of the PowerStation.

Also, make sure that the surface of the enclosure on which the PowerStation is mounted is flat and free of raised or depressed areas.

## Backlight Accessibility Guidelines

Occasionally, you will need to replace the backlight bulb of the PowerStation. The PowerStation is designed to allow you to replace the faceplate and backlight bulb while the unit is mounted. To do so requires you to mount the unit so that the area surrounding the faceplate is completely unobstructed.

See *Replacing the Backlight Bulb* on page 54 for more information on replacing the backlight bulb. You can use this information as an aid in deciding how to design the PowerStation's enclosure to allow for easy removal of the PowerStation's faceplate and backlight assembly.

## AC Power Guidelines

If you have purchased the optional AC power supply for the PowerStation, you must select a location that provides protection from dust, oil, moisture, and corrosive vapors. If you have a large enough enclosure, you can mount the power supply in the enclosure with the unit.

**Note** If you decide to mount the power supply in an enclosure, mounting it flat on the bottom of the enclosure or horizontally on the side of the enclosure provides the best convection cooling.

# Preparing the Location

Once you select a location, you can begin preparing the location to accept the unit. Prior to installing the PowerStation, you will need to create a cutout for the unit and clean the area of any dirt or debris that may come in contact with the unit.

## Creating the Cutout

The PowerStation comes with a template that is designed to simplify the task of creating the cutout for the unit. Follow these steps to create the cutout:

1. Securely attach the template to the mounting surface.
2. Cut out the shaded area on the template referred to as the 'Panel Cutout Area.' To maintain the flatness of the mounting surface, CTC recommends that you **cut** out the Panel Cutout Area rather than punch it out.
3. Debur the edges of the metal cutout.
4. Ensure that the mounting surface has remained flat and that the panel surface is clean and free of foreign materials.

## Preparing to Use an AC Power Supply

When you purchase the optional AC power supply for the PowerStation, you receive a template that you can use to prepare the location for the power supply. Follow these steps to prepare the power supply mounting surface:

1. Securely attach the template to the mounting surface.
2. Drill and debur four 0.17" (4.3mm) holes.



---

## Installing the Unit

Once you have prepared the mounting location for the PowerStation and the AC power supply (if purchased), you can begin installing the unit.

### Mounting the PowerStation

The PowerStation is designed to be mounted using four screws. These screws are secured to the unit with metal clips. For your convenience, CTC includes all necessary hardware for mounting the unit. Follow these steps to mount the unit:

1. Prepare the power source for the unit by sliding the positive and negative wires into the appropriate slots on the power connector.
2. Connect the ground cable from the power connector to an earth ground.
3. Slide the gasket around the outside of the PowerStation case, positioning it flush against the back of the faceplate.
4. Gently insert the PowerStation into the cutout.
5. Prepare the mounting hardware that was supplied with the unit. Begin by threading each of the supplied metal clips with a screw. Snap each of the clips onto the outside of the unit.
6. Attach the power connector that you prepared in steps 1 and 2 to the back of the unit.
7. Tighten each of the mounting screws.

**Important** The unit must fit flush against the enclosure. Tighten the nuts in a crosswise sequence to ensure a good seal and prevent damage to the unit.

### Mounting the AC Power Supply

The AC power supply is designed to be mounted using two metal brackets. These brackets are secured to the mounting surface using four screws. For your convenience, CTC includes all necessary hardware for mounting the power supply. Follow these steps to mount the power supply:

1. Prepare the power source for the unit by sliding the positive and negative wires into the appropriate slots on the power connector.

## Installing the PC/104 Adapter

---

2. Connect the ground cable from the power connector to an earth ground.
3. Attach the power supply to the mounting surface using the supplied metal brackets.
4. Connect the power cord from the power supply to an AC power source.
5. Secure the power cable to the power supply using the supplied L-shaped metal bracket and nut.
6. Attach the power connector that you prepared in steps 1 and 2 to the back of the PowerStation.

## Installing the PC/104 Adapter

The PowerStation supports an optional PC/104 adapter. The PC/104 adapter allows you to connect PC/104 I/O expansion modules to the back of the unit for communicating with the ISA bus.

## Electrostatic Discharge Precautions

Modern integrated electronic devices, especially CPUs and memory chips, are extremely sensitive to electrostatic discharges (ESD) and fields. Before you install the PC/104 adapter, be sure to follow these simple precautions to protect you and the PowerStation from harm resulting from ESD.

1. To avoid electric shock, always disconnect the power from the PowerStation before you remove the backshell cover or separate the backshell from the front panel. Do not touch any components of the CPU card or other cards while the PowerStation is on.
2. Disconnect power before making any hardware configuration changes. The sudden rush of power as you connect a jumper or install a card may damage sensitive electronic components.
3. Only handle internal components in an ESD safe location using appropriate grounding methods.
  - Always ground yourself to remove any static charge before you touch the CPU card.
  - Be particularly careful not to touch the chip connectors.

- Keep the adapter in its anti-static packaging when it is not installed in the PowerStation, and place it on a static dissipative mat when you are working on it.
- Wear a grounding wrist strap for continuous protection.

## Installing the Adapter

After you have taken the proper ESD safety precautions, you are ready to install the PC/104 adapter. Follow these steps to install the adapter:

1. Turn off the PowerStation.
2. Disconnect the power source from the PowerStation.
3. Remove the unit from its enclosure if the unit was previously installed.
4. Place the unit face-down on a static dissipater mat in a location free from dirt and moisture and protected against static discharge.

**Important** The PC/104 adapter kit includes an ESD wrist strap. To prevent static discharge, you must wear this wrist strap, or an equivalent one, connected to a good known earth ground.

5. Copy the PowerStation serial number from the backshell label onto the label on the back of the PC/104 card cover that was included with the PC/104 adapter kit.
6. Remove the two screws that secure the PC/104 adapter cover.

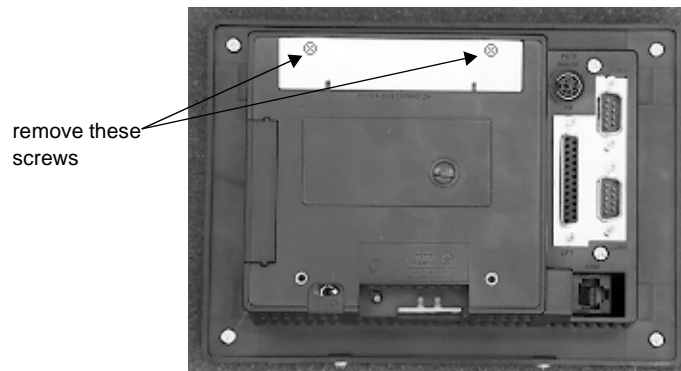

7. Carefully align the PC/104 adapter connector over the mother board connector.

## Installing the PC/104 Adapter

---

8. Press down firmly on the PC/104 adapter until the adapter seats in the connector. The adapter will protrude slightly from the backshell.
9. Install the new PC/104 adapter cover on the backshell using the screws that you removed in step 6.
10. Install standoffs in the lower two corners of the backshell. The standoffs are included with the PC/104 adapter kit.
11. Install a PC/104 card onto the adapter.
12. Align the PC/104 card cover over the PC/104 card. There are three detachable sides of the PC/104 card cover. Snap off the side of the cover necessary for the PC/104 card connector to show through.
13. Secure the PC/104 card cover to the backshell using the screws provided with the PC/104 adapter kit.
14. Perform any cable connections or further setup required for the PC/104 card prior to mounting the unit back in its enclosure.

# Maintaining and Troubleshooting the P1 PowerStation

The P1 PowerStation has been designed to provide years of trouble-free operation even in the harshest environments. However, you will occasionally need to perform routine maintenance on some of the PowerStation's components.

This chapter provides instructions on cleaning the touch screen, replacing the flash drive, and performing various internal maintenance procedures.

## Chapter Contents

---

<i>Cleaning the Touch Screen</i>	46
<i>Replacing the Flash Drive</i>	46
<i>Performing Internal Maintenance</i>	47
<i>Resolving Common Problems</i>	58

## Cleaning the Touch Screen

Occasionally, you might find it necessary to clean the touch screen of the PowerStation. Clean the touch screen using warm soapy water and a cloth. You may also use any non-abrasive cleaner. See *Faceplate Chemical Resistance* on page 20.

Do not use any harsh material or powder, such as steel wool or abrasive cleansers, to clean the polyester surface. The surface is sensitive to scraping, sharp blows, or punctures. Thus, keep screwdrivers or other sharp objects away from the surface of the touch screen.

**Warning** Do NOT clean the unit while Interact is in Run mode. Clean the unit while power is removed to keep from inadvertently activating an Interact device (button, slide, etc.).

## Replacing the Flash Drive

The P1 PowerStation uses a removable flash drive for storage purposes. CTC recommends that you purchase at least one additional flash drive to serve as a backup for your primary flash drive. You can also purchase additional flash drives to store different projects. Using the steps below, you can easily remove and replace the flash drive:

1. Turn off power to the unit.
2. Face the back of the unit, and grasp the left side of the flash drive.

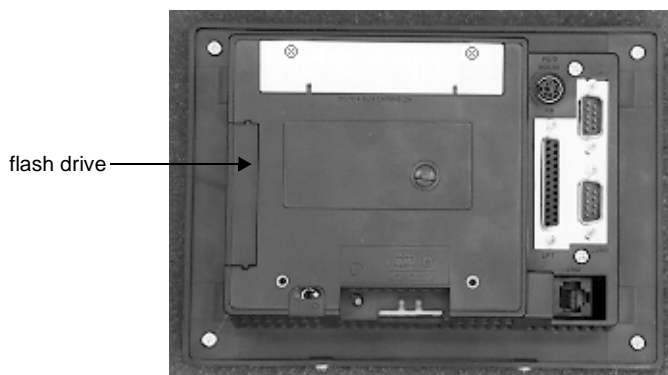

3. Remove the module by sliding it out of its slot towards you.

4. Install the new module with the ridged surface facing out.

## Performing Internal Maintenance

This section describes how to disassemble the P1 PowerStation to perform internal maintenance. This section will show you how to perform the following operations:

- Remove the backshell
- Remove and replace DRAM
- Remove and replace the touch screen
- Remove and replace the backlight bulb
- Reconfigure the COM2 settings

## Electrostatic Discharge Precautions

Modern integrated electronic devices, especially CPUs and memory chips, are extremely sensitive to electrostatic discharges (ESD) and fields. Before you disassemble the PowerStation, be sure to follow these simple precautions to protect you and the PowerStation from harm resulting from ESD.

1. To avoid electric shock, always disconnect the power from your PowerStation before you remove the backshell cover or separate the backshell from the front panel. Do not touch any components of the CPU card or other cards while the PowerStation is on.
2. Disconnect power before making any hardware configuration changes. The sudden rush of power as you connect a jumper or install a card may damage sensitive electronic components.
3. Only handle internal components in an ESD safe location using appropriate grounding methods.
  - Always ground yourself to remove any static charge before you touch the CPU card.
  - Be particularly careful not to touch the chip connectors.
  - Keep any card (DRAM) in its anti-static packaging when it is not installed in the PowerStation, and place it on a static dissipative mat when you are working on it.
  - Wear a grounding wrist strap for continuous protection.

## Disassembling the PowerStation

If you have read and understand the ESD safety precautions, you are ready to disassemble the PowerStation. Follow these steps to disassemble the unit:

**Important** As you begin to disassemble the unit, you will encounter several different screw sizes. When you reassemble the PowerStation, be sure to replace the same size screw in the same location as the one that was removed. Failure to do so could result in damage to the P1.

1. Turn off power to the unit.
2. Disconnect the unit from the power source.
3. Remove the unit from the enclosure, if installed.
4. Place the unit on a static dissipater mat in a location free from dirt and moisture and protected against static discharge. You must also wear an ESD wrist strap connected to a good known earth ground.
5. Place the unit on its back and remove the two screws securing the touch screen to the backshell.





- Carefully lift the bottom of the touch screen approximately two inches while disengaging the tabs that secure the touch screen to the top of the unit.

**Important** When removing the touch screen from the unit, keep the touch screen as parallel to the unit as possible to prevent damage to the touch screen cable.

- Separate the touch screen plug from the touch screen connector, and lay the touch screen aside.

**Note** The touch screen plug is attached to the unit, and the touch screen connector is attached to the touch screen. If you are replacing touch screen or backlight bulb, you do not need to remove the backshell. Skip the remaining steps and refer to the appropriate section of this chapter. For information on replacing the touch screen, see page 53; for information about replacing the backlight bulb, see page 54.

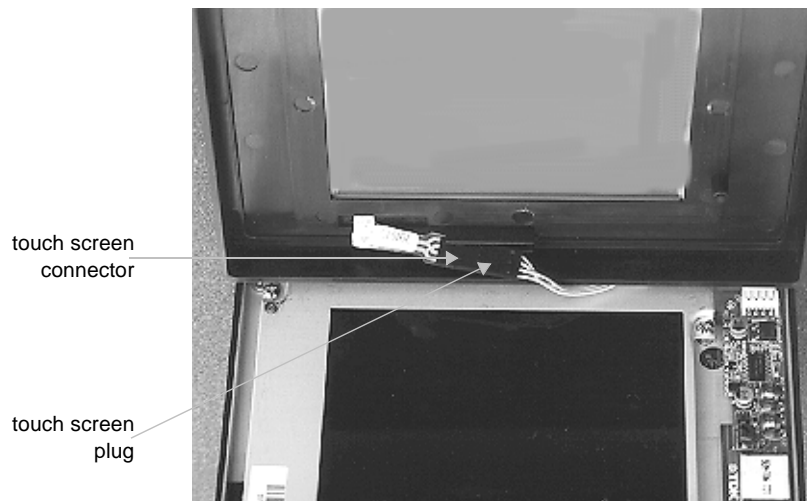

- Place the unit face down on a clean surface to avoid scratching the LCD display.
- Remove the flash drive by grasping its left side and sliding it out of the slot towards you.

## Performing Internal Maintenance

---

10. Remove the five short screws and one long screw securing the backshell to the faceplate.

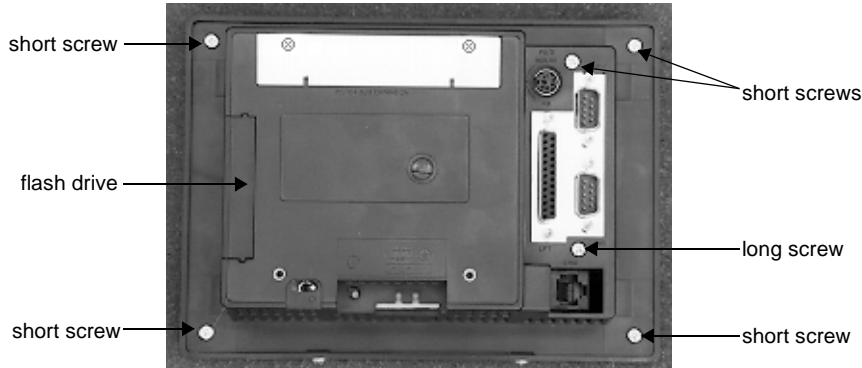

11. Lift the backshell off the faceplate and lay it aside. Disassembly is complete.
12. Proceed to the specific configuration or replacement procedures you need to perform.
  - See *Changing the COM2 Jumpers* on page 50
  - See *Replacing the DRAM* on page 52
  - See *Replacing the Touch Screen* on page 53
  - See *Replacing the Backlight Bulb* on page 54

## Changing the COM2 Jumpers

The COM2 port of the PowerStation comes pre-configured for RS-485 communications. If you need to reconfigure the COM2 port for RS-232-C or RS-422 communications, you must change the COM2 jumpers using the procedure described below:

1. Perform the disassembly procedures described beginning on page 48.

2. Remove the screw that secures the I/O daughter board to the CPU board.

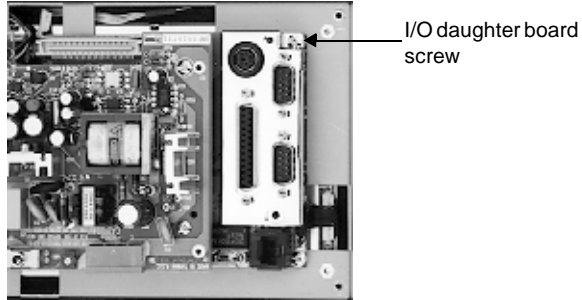

3. Carefully lift up on the I/O daughter board and lay aside. Be careful not to lose the standoffs supporting the I/O daughter board.
4. Observe the six jumpers located next to the Ethernet J45 connector.

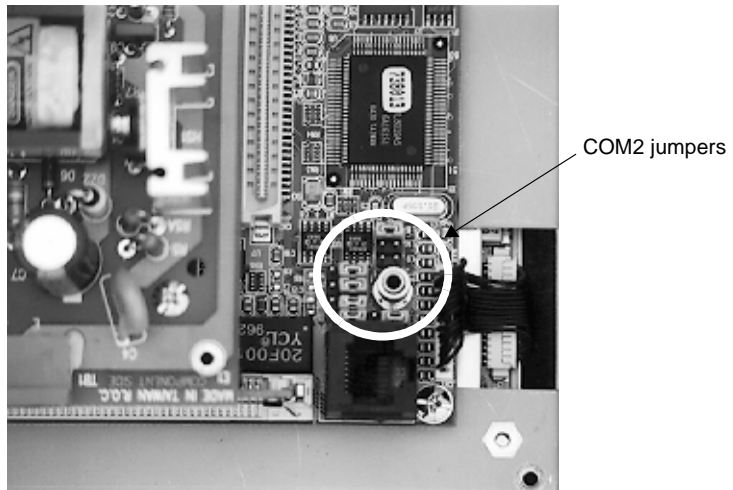

5. Refer to the graphic on the next page, and move the jumpers accordingly to change the protocol from RS-485 to RS-232-C or RS-422.

## Performing Internal Maintenance

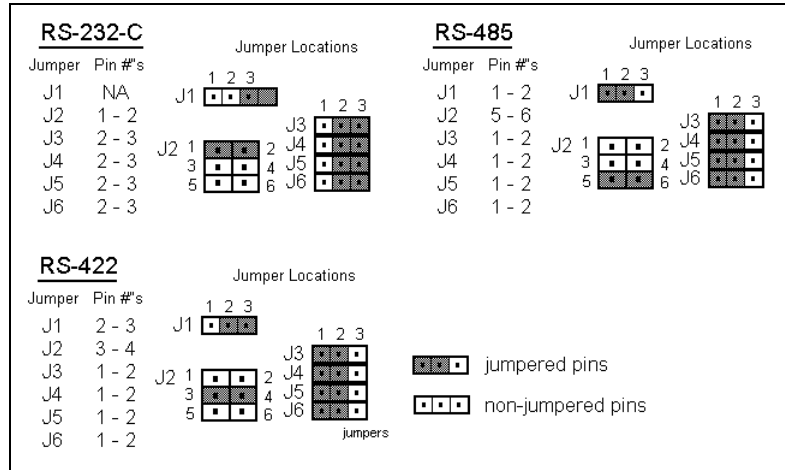

6. Once you have moved the jumper to the correct pins, position the I/O daughter board over the daughter board connector and standoffs. Press the daughter board onto the connector.
7. Secure the board using the screw removed in step 2.
8. Perform the reassembly procedures described beginning on page 56.

## Replacing the DRAM

If you need to upgrade or replace the P1 PowerStation's DRAM, CTC carries replacement SIMM modules. The P1 PowerStation comes with a 4MB 72-pin SIMM standard, but you can replace that module with either an 8MB or 16MB 72-pin SIMM for greater capacity. Follow these steps to replace the DRAM:

1. Perform the disassembly procedures described beginning on page 48.

2. With the backshell removed, locate the DRAM module which is located below the power switch.

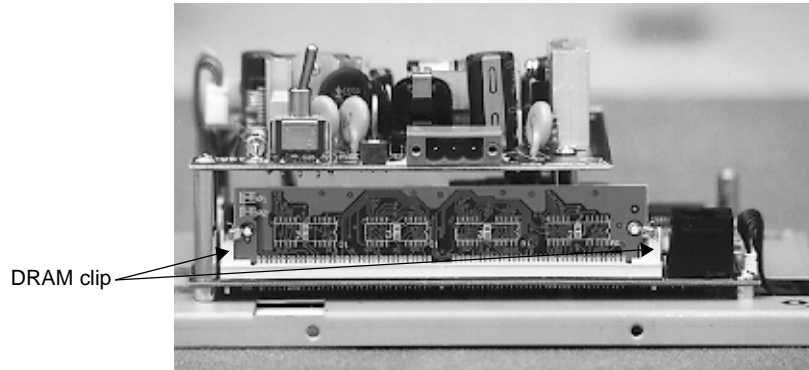

3. Press outward on the two clips holding the DRAM module in place. The module pushes outward.
4. Slide the module out of its socket.
5. Place the new module in the socket at an angle. The chips must face in towards the PowerStation circuitry.
6. Press forward on the module until the clips catch, securing the module in place. The tabs must fit into the holes on the board.
7. Perform the reassembly procedures described beginning on page 56.

## Replacing the Touch Screen

Occasionally you will need to replace the P1 PowerStation's touch screen, depending on the environment where you are operating the unit. The PowerStation's touch screen is designed to be replaced without removing the unit from its enclosure. Follow these steps to replace the touch screen:

1. Unpack the replacement touch screen, and examine it for damage or defects.
2. To remove the old touch screen, perform steps 1 through 7 of the disassembly procedures described beginning on page 48.
3. To install the new touch screen, perform steps 6 through 13 of the reassembly procedure beginning on page 57.

## Replacing the Backlight Bulb

Backlight bulb life is determined by the number of hours in continuous use. The P1 PowerStation's backlight bulb has an average life expectancy of 10,000 hours or 416 days (24 hours/day). The PowerStation's backlight bulb is designed to be replaced without removing the unit from its enclosure. Follow these steps to replace the backlight bulb:

1. Unpack the replacement backlight bulb, and examine it for damage or defects.
2. To remove the touch screen perform steps 1 through 7 of the disassembly procedures described beginning on page 48.
3. Remove the four screws that secure the display.

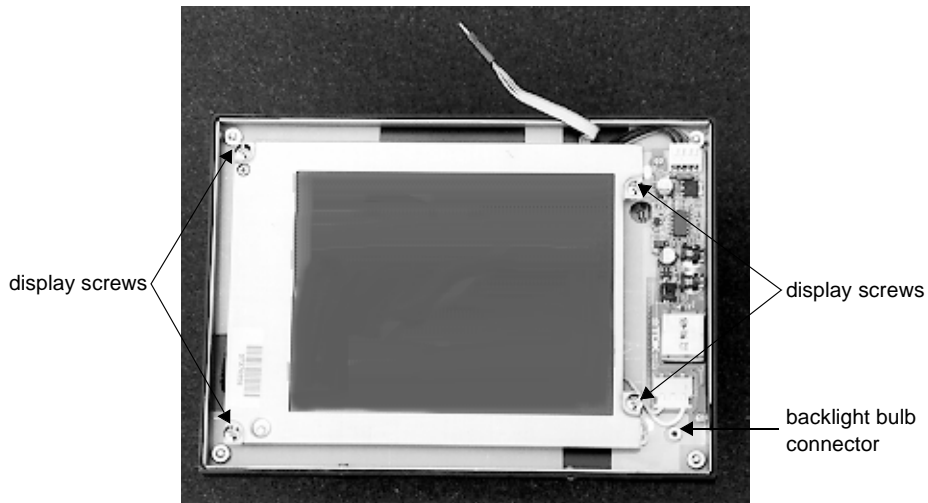

4. Disconnect the backlight connector cable from the board.
5. Carefully lift the display to reveal the display connector.

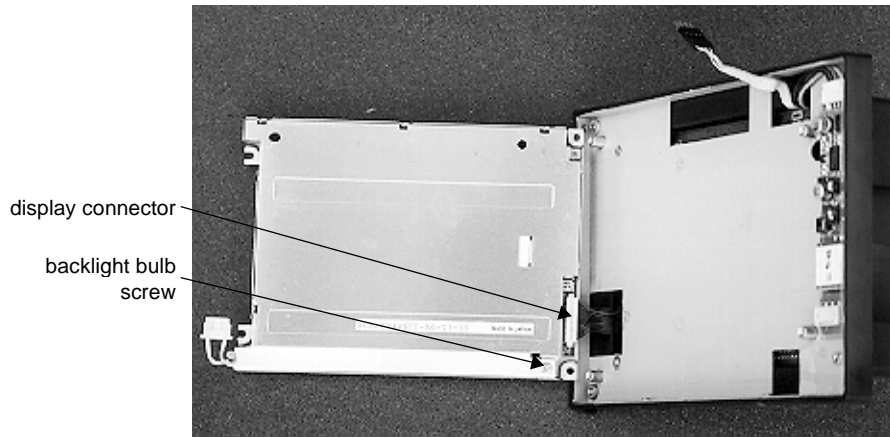

6. Disconnect the display connector by gently pulling on the connector.
7. Remove the screw securing the backlight bulb to the display.
8. Lift the bulb out of the display channel.
9. Install the replacement backlight bulb in the display channel, and install the screw removed in step 7. The bulb only fits one direction (cable to the left).
10. Insert the display cable into the display connector. The red wire is at the top of the cable, and the cable socket is facing up.
11. Place the display over the standoffs. Be sure to wrap the backlight bulb cable around the lower right standoff. This will ensure the bulb connector has enough room to connect to its mate.
12. Connect the backlight cable to the backlight board. The colored wire is to your left.
13. Install the four screws removed in step 3.
14. Perform steps 6 through 13 of the reassembly procedure beginning on page 57 to reinstall the touch screen.

## Reassembling the PowerStation

This section describes how to reassemble the PowerStation after you have finished performing internal maintenance on the unit. The first five steps describe how to reinstall the backshell; steps 6 through 13 describe how to reinstall the touch screen.

### To reassemble the PowerStation:

1. Place the backshell over the unit. Make sure the touch screen cable does not become pinched between the backshell and the unit.

**Important** If a PC/104 adapter is installed, be careful to align the adapter between the card rails molded into the backshell.

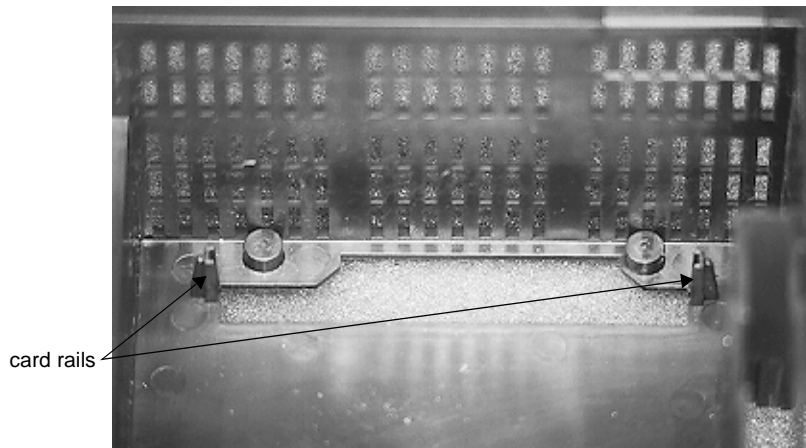

2. Press the backshell down firmly.
3. Install the five short screws and one long screw that you removed when you removed the backshell. The long screw is installed between the COM1 port (the bottom serial port) and the Ethernet RJ45 port. If necessary, refer to the graphic on page 50.
4. Install the flash drive by aligning the tabs with the slots in the backshell and pressing the module firmly into place.
5. Turn the unit over to install the touch screen.



6. Locate pin 1 on the touch screen plug, and align it with pin 1 of the touch screen connector. A “1” identifies pin 1 on the touch screen plug.



7. Connect the touch screen plug to the touch screen connector.
8. Insert the touch screen cable into the groove on the back of the touch screen. This ensures that the touch screen cable does not become pinched between the touch screen and the display.
9. Place the touch screen on the display. Be sure that the touch screen snaps onto the tab on the top of the unit.
10. Secure the touch screen to the backshell by installing the two screws removed in step 5 of the disassembly procedures on page 48.
11. Install the unit in its protective enclosure.
12. Restore power to the unit.
13. Power up the unit.

## Resolving Common Problems

This section provides some basic troubleshooting steps to help you identify and correct problems you may encounter with the PowerStation. If you encounter a problem, please consult this section to see if you can correct the problem yourself. If you encounter a problem that is not documented in this section, contact your CTC equipment supplier or CTC technical support at (513) 248-1714.

### Resolving Problems When Powering the Unit

One of the most common problems that users encounter with PCs occurs while booting up their system. This section describes some possible problems and solutions for booting up the PowerStation.

#### Resolving AUTOEXEC.BAT and CONFIG.SYS problems

Some bootup problems are caused by a corrupted or modified AUTOEXEC.BAT or CONFIG.SYS file. CTC includes backup copies of these files in the \CTC directory of the PowerStation and on the P1 ROM-DOS Utilities Disk. These files are AUTOEXEC.CTC and CONFIG.CTC. The text for AUTOEXEC.CTC appears below:

```
@ECHO OFF
PROMPT $p$g
PATH C:\;C:\CTC
REM *****
REM Install touchscreen drivers
REM *****
SET TCHPATH=C:\ATS
C:\ATS\ATSMOUSE
REM *****
REM Set up Interact environment variables for CTC Shell
REM *****
SET INTERACT=C:\INTERACT
SET INTERACT_FILES=C:\INTERACT\APPFILES
SET INTERACT_STARTUP=C:\STARTUP
REM *****
REM Call AUTOEXEC.BAT file contained in project, if it exists
REM *****
IF EXIST C:\STARTUP\AUTOEXEC.BAT CALL C:\STARTUP\AUTOEXEC.BAT
REM *****
REM Uncomment next statement to load network batch file
REM *****
```

```
REM C:\NET\NET.BAT
REM *****
REM Start the CTC Shell
REM *****
CD \CTC
PSU
```

The text for CONFIG.CTC appears below:

```
FILES=30
LASTDRIVE=N
```

If at any time you suspect a problem with either the AUTOEXEC.BAT or the CONFIG.SYS file of the PowerStation, use the DOS **copy** command to create a backup copy of your current file, and overwrite the suspect file with the appropriate backup file. For example, if the AUTOEXEC.BAT file becomes suspect, type the following commands at the DOS prompt:

```
copy autoexec.bat autoexec.old
copy \ctc\autoexec.ctc autoexec.bat
```

At this time, you cannot edit the AUTOEXEC.BAT or CONFIG.SYS on the PowerStation but, you can use the Interact Project Manager (IPM) Super User mode to edit these files on your development PC.

**Note** You may encounter an out of memory error on your development PC if you attempt to load IPM and MS-DOS Edit at the same time. If you encounter this error, reduce the number of device drivers and/or TSRs that reside in conventional memory.

**Important** You cannot load the touch screen driver and a serial mouse driver such as MOUSE.COM simultaneously. The PowerStation will only load the driver that is specified first in the AUTOEXEC.BAT file.

## Resolving other problems during power up

This section lists some additional problems and solutions for booting up the PowerStation. The problem is listed first followed by a list of possible solutions. Begin with the first one, and continue through the list until you have solved the problem or reached the end of the list.

### **During power up, the boot sequence halts with the AMIBIOS screen displayed.**

1. Check for a loose flash drive, and power cycle the PowerStation.
2. If the problem persists, contact your CTC equipment supplier or CTC's technical support for assistance.

### **During power up, a chirping sound can be heard.**

1. The touch screen driver is not loading. Check the AUTOEXEC.BAT file. See *Resolving AUTOEXEC.BAT and CONFIG.SYS problems* on page 58 for more information.
  - a. Verify that the touch screen drivers are being loaded. Look for the following lines:

```
SET TCHPATH=C:\ATS  
C:\ATS\ATSMOUSE
```
  - b. Verify that a serial mouse driver such as MOUSE.COM is not being loaded before the touch screen driver. Look for the following line:

```
C:\MOUSE.COM
```
2. If the problem persists, contact your CTC equipment supplier or CTC's technical support for assistance.

### **During power up, the LED Power indicator on the front of the unit does not light.**

1. Check to see if the power switch is in the **On** position and the PowerStation is operating correctly.
  - a. If the PowerStation appears to be operating correctly, the LED indicator may be defective. Contact your CTC equipment supplier or CTC's technical support for assistance.
  - b. If the PowerStation does not appear to be operating correctly, power cycle the PowerStation.
2. Check the AC power supply, if purchased.
  - a. Check the AC power supply LED. If the AC LED is not lit, either the AC power line is bad or the AC power supply is defective.
  - b. Check the AC power line to determine if the AC voltage is good.
3. Check the DC power line, if present, to determine if the DC voltage is between 18-30VDC. A voltage of 24VDC is ideal.
4. Check the power connector to determine if the leads are properly connected and not reversed (positive line connected to the negative terminal). The ground lead must also be properly connected.

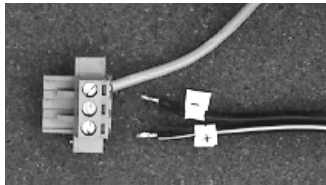

5. Check the PC/104 adapter, if installed. Remove the adapter, and power cycle the unit. If the LED comes on, the PC/104 card was bad.
6. If the problem persists, contact your CTC equipment supplier or CTC's technical support for assistance.

## Resolving Problems After Powering the Unit

This section lists some possible problems and solutions that may occur after you power up the PowerStation. The problem is listed first followed by a list of possible solutions. Begin with the first one, and continue through the list until you have solved the problem or reached the end of the list.

### **After power up, the screen appears to be blank or very dim.**

1. Check to see if the power switch is in the **On** position and the LED Power indicator on the front of the PowerStation is lit.
  - a. If the PowerStation appears to be operating correctly, adjust the contrast of the display by adjusting the potentiometer on the back of the unit next to the power switch.
  - b. If the PowerStation does not appear to be operating correctly, power cycle the unit.
2. Replace the backlight by following the procedures found beginning on page 54.
3. If the problem persists, contact your CTC equipment supplier or CTC's technical support for assistance.

### **After power up, the DOS prompt is displayed instead of the PowerStation Shell MAIN MENU.**

1. If the PowerStation appears to be operating correctly otherwise, reboot the unit.
2. The AUTOEXEC.BAT file may be corrupted or has been modified. See *Resolving AUTOEXEC.BAT and CONFIG.SYS problems* on page 58 for information about correcting this problem.
3. If the problem persists, contact your CTC equipment supplier or CTC's technical support for assistance.

### **After power up, the touch screen does not work.**

1. If the PowerStation appears to be operating correctly otherwise, reboot the unit.
2. The touch screen calibration might be in error. See *Calibrating the Touch Screen* on page 31 to calibrate the touch screen.
3. Check the AUTOEXEC.BAT file. See *Resolving AUTOEXEC.BAT and CONFIG.SYS problems* on page 58 for more information.
  - a. Verify that the touch screen drivers are being loaded. Look for the following lines:

```
SET TCHPATH=C:\ATS  
C:\ATS\ATSMOUSE
```
  - b. Verify that a serial mouse driver such as MOUSE.COM is not being loaded before the touch screen driver. Look for the following line:

```
C:\MOUSE.COM
```
4. If the problem persists, contact your CTC equipment supplier or CTC's technical support for assistance.

### **After calibrating the touch screen, it either does not work or follow your finger.**

1. Make sure a serial mouse is not connected to the unit. The touch screen will NOT work with a serial mouse.
2. Make sure that you are using a Microsoft PS/2 mouse and the supplied Y adapter cable to connect the mouse to the keyboard port.
3. Check the touch screen cable.
  - a. Make sure the touch screen cable has been properly connected. Pin1 must be connected to Pin1.
  - b. Inspect the touch screen cable for broken, loose, or frayed wiring. If you encounter wiring problems, replace the touch screen following the procedure on page 53.
4. Replace the touch screen following the procedure on page 53.
5. If the problem persists, contact your CTC equipment supplier or CTC's technical support for assistance.

**After selecting the Go To Interact button from the Shell MAIN MENU, Interact doesn't run.**

1. Verify that Interact is loaded for this project. Go to the Shell MAIN MENU, and observe the selection for INTERACT TYPE. If the word UNKNOWN is displayed, return to your development system, and download a project that has Interact included. Refer to the IPM User Guide for information on downloading projects.
2. If the problem persists, contact your CTC equipment supplier or CTC's technical support for assistance.

**After selecting the Go To Interact button from the Shell MAIN MENU, Interact loads, but the screen is blank.**

1. Interact device driver communications have stopped. Check the following:
  - a. On a development system, check to ensure you selected the correct device driver communications parameters (baud rate, number of data bits, etc.)
  - b. Go to the Shell SETTINGS menu and ensure the COM port that the driver is using is selected.
  - c. Make sure the COM2 hardware jumpers are selected for the particular protocol used with the driver.
2. If the problem persists, contact your CTC equipment supplier or CTC's technical support for assistance.

**After power up, a PS/2 mouse does not work.**

1. Make sure that you are using a Microsoft PS/2 mouse. Some PS/2 style mice that claim to be Microsoft compatible, will not work correctly with the PowerStation. Do NOT use a serial mouse with a serial to PS/2 port adapter.
2. Make sure the mouse is plugged into the Y cable attached to the keyboard port. Do NOT plug the mouse directly into the keyboard port.
3. If the problem persists, contact your CTC equipment supplier or CTC's technical support for assistance.

**After power up, a serial mouse does not work.**

1. See *Connecting a serial mouse* on page 13 for information on how configure the PowerStation to accept a serial mouse.
2. If the problem persists, contact your CTC equipment supplier or CTC's technical support for assistance.

### **After power up, the keyboard does not work.**

1. Make sure the keyboard is plugged into the Y cable attached to the keyboard port.
2. Make sure the keyboard is an AT style keyboard NOT an XT style.
3. Try using a new Y adapter cable.
4. Try using a new keyboard.
5. If the problem persists, contact your CTC equipment supplier or CTC's technical support for assistance.

### **After power up, the Ethernet port does not work.**

1. Make sure the Ethernet cable is plugged in.
2. Make sure the networking software is being loaded. Check the AUTOEXEC.BAT file. See *Resolving AUTOEXEC.BAT and CONFIG.SYS problems* on page 58 for more information.
  - a. Verify that the following line does NOT have the word "REM" in front of it:  
`C:\NET\NET.BAT`
3. Make sure that you have properly configured the networking software. See *Configuring the Ethernet Interface* on page 33 for more information.
4. If the problem persists, contact your CTC equipment supplier or CTC's technical support for assistance.



## A

- AC power guidelines 39
- AC power supply 22, 60
- AUTOEXEC.BAT
  - command line parameters 34
  - troubleshooting 58, 61, 62, 64

## B

- backlight bulb
  - accessibility guidelines 39
  - connector 54
  - replacement 22, 54

## C

- cable diagrams
  - RS-232-C 12
  - RS-422 12
  - RS-485 12
- chemical resistance (faceplate) 20
- cleaning the touch screen 46
- COM1 pinouts 11
- COM2
  - changing protocols 50
  - jumper settings 51, 52
  - pinouts 11
- common problems 58
- CONFIG.SYS
  - troubleshooting 58, 59
- connecting a PS/2 mouse 17
- connecting a serial mouse 13
- connecting to a parallel printer 17
- connecting to a PC 13
- connecting to a serial printer 15
- Customer Support Services 5

## D

- display connector 55
- display types
  - color STN 8
  - monochrome 8
- documentation standards 2
- DRAM
  - picture 53
  - replacement 21, 52
- drive definitions 8

## E

- electrical guidelines 38
- electrostatic discharge precautions
  - 42, 47
- enclosure guidelines 39
- environmental guidelines 38
- Ethernet port
  - configuration 33
  - pinouts 17
  - troubleshooting 64

## F

- faceplate chemical resistance 20
- flash drive
  - replacement 21, 46

## I

- I/O daughter board 51
- important concepts 3
- installation
  - creating the cutout 40
  - mounting the AC power supply 41
  - mounting the PowerStation 41
  - preparing to use an AC power supply 40
  - selecting a location 38

# Index

---

Interact Project Manager User Guide  
2  
IRQs 35

## K

keyboard port  
connecting a keyboard 17  
connecting a PS/2 mouse 17

## L

location of unit  
AC power guidelines 39  
backlight accessibility guidelines  
39  
electrical guidelines 38  
enclosure guidelines 39  
environmental guidelines 38  
faceplate considerations 38  
temperature guidelines 38

## M

maintenance  
*See* P1 PowerStation, internal  
maintenance  
memory map 9  
menu definitions  
Exit 31  
Go To Interact 31  
Help 26  
Settings 27  
System Information 29  
Touch Screen Calibration 30  
MODE.COM 15  
mouse  
PS/2 17  
serial 13  
mouse port  
*See* keyboard port

## O

optional components  
AC power supply 22  
PC/104 adapter 22

## P

P1 PowerStation  
connectors 10  
disassembly 48  
display types 8  
documentation set 2  
drive definitions 8  
important concepts 3  
installation 37  
internal maintenance 47  
IRQs 35  
memory map 9  
optional components 22  
power up 24  
reassembly 56  
release notes 2  
replacement components 21  
specifications 18  
template 2  
troubleshooting 58  
User Guide 2  
parallel port  
connecting to a parallel printer 17  
pinouts 16  
parallel printer 17  
PC/104 adapter  
card rails 56  
electrostatic discharge precau-  
tions 42  
installation 42  
specifications 22  
power connector 60  
power up 24

- PowerStation
    - See* P1 PowerStation
  - PowerStation Shell Utility
    - See* Shell
  - printer
    - parallel 17
    - serial 15
  - protocol
    - See* COM2, changing protocols
  - PS/2 mouse 17, 63
- R**
- replacement components
    - backlight bulb 22
    - DRAM 21
    - flash drive 21
    - touch screen 21
  - replacement procedures
    - backlight bulb 54
    - DRAM 52
    - flash drive 46
    - touch screen 53
  - RS-232-C cable diagram 12
  - RS-422 cable diagram 12
  - RS-485 cable diagram 12
- S**
- serial mouse 13, 63
  - serial ports
    - cable diagrams 12
    - changing COM2 protocol 50
    - COM1 pinouts 11
    - COM2 jumpers 51, 52
    - COM2 pinouts 11
    - connecting a serial mouse 13, 63
    - connecting to a PC 13
    - connecting to a serial printer 15
  - serial printer 15
- Shell**
- MAIN MENU 24, 26
  - menu definitions 25
  - selecting screen options 25
- Shell MAIN MENU**
- Exit 31
  - Go To Interact 31
  - Help 26
  - Settings 27
  - System Information 29
  - Touch Screen Calibration 30
- specifications
- electrical 19
  - environmental 20
  - physical 18
  - testing 19
- T**
- temperature guidelines 38
  - touch screen
    - cable 57
    - calibration 31
    - cleaning 46
    - connector 57
    - replacement 21, 53
  - troubleshooting
    - AC power supply 60
    - AUTOEXEC.BAT 58, 61, 62, 64
    - boot problems 58, 59
    - common problems 58
    - CONFIG.SYS 58, 59
    - Ethernet port 64
    - Interact problems 63
    - keyboard 64
    - PS/2 mouse 63
    - serial mouse 63
    - touch screen 60, 62

# Index

---